

FOLD

=STRAIGHT GRAIN=

5594 Dress With Ties  
SKIRT\_FRONT\_PART  
Fabric type TOP\_FABRIC, Piece qty =(1,0)  
X UNISEX

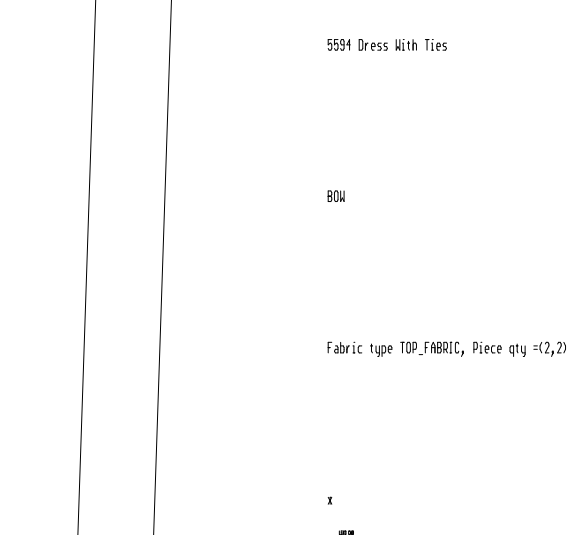
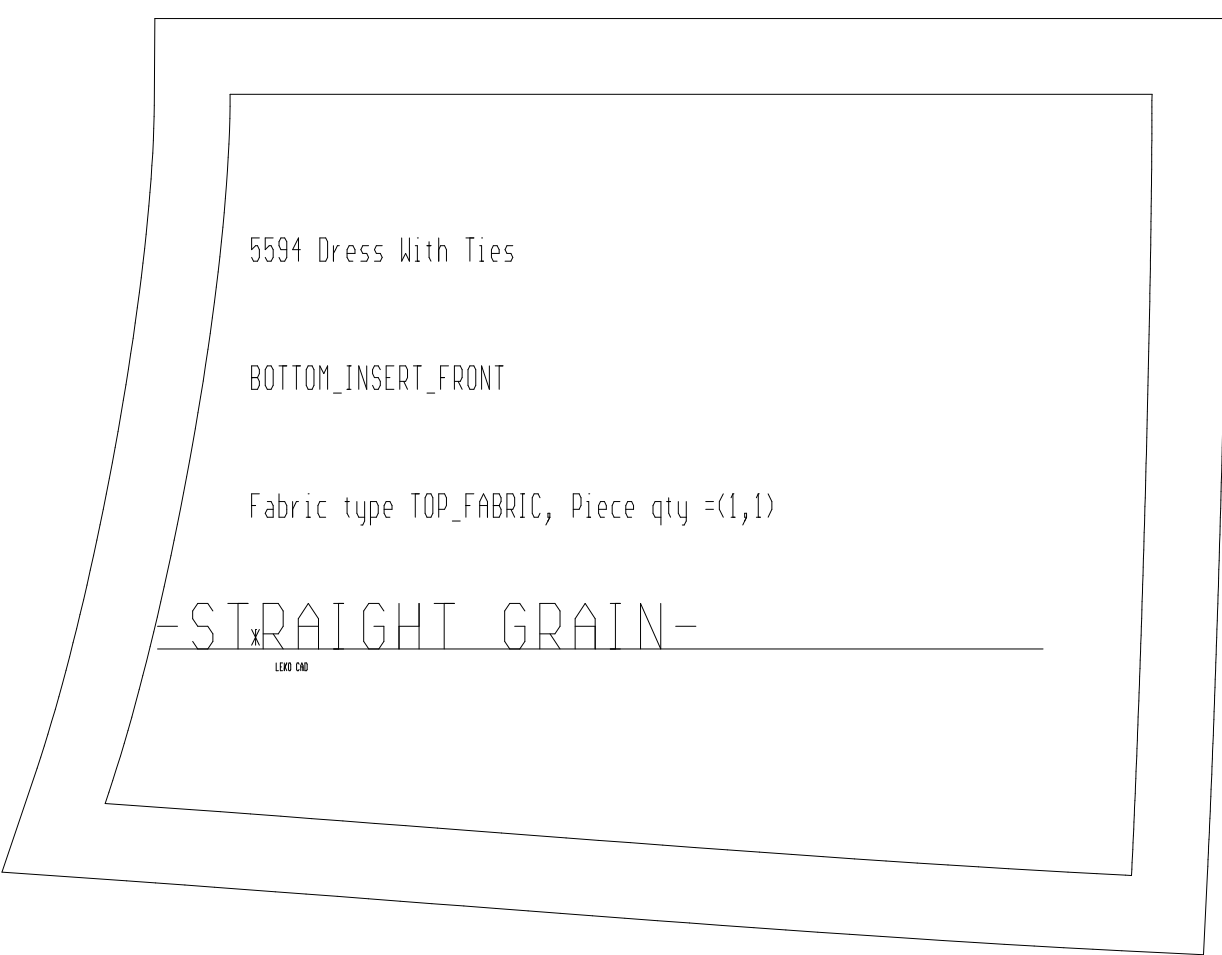
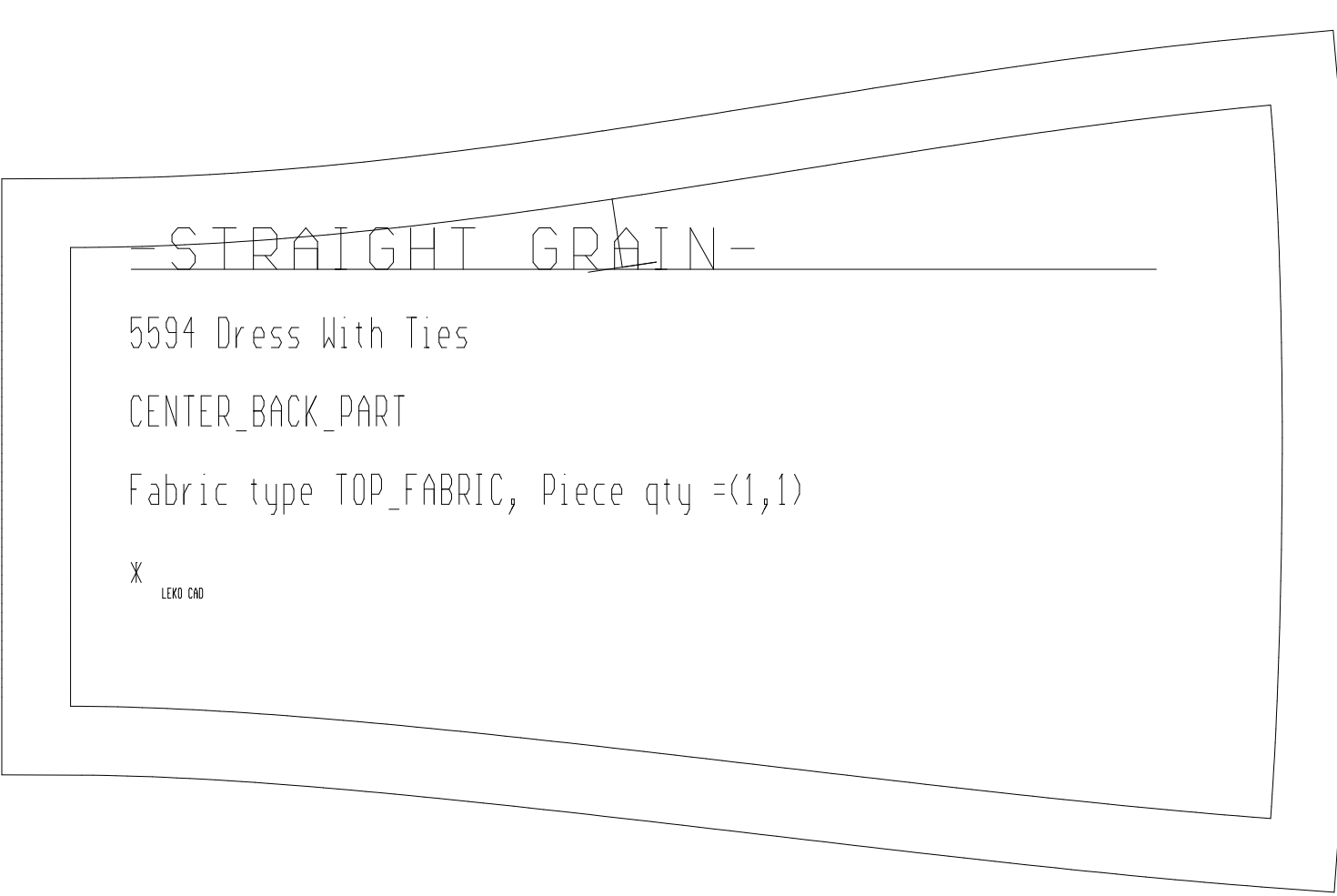
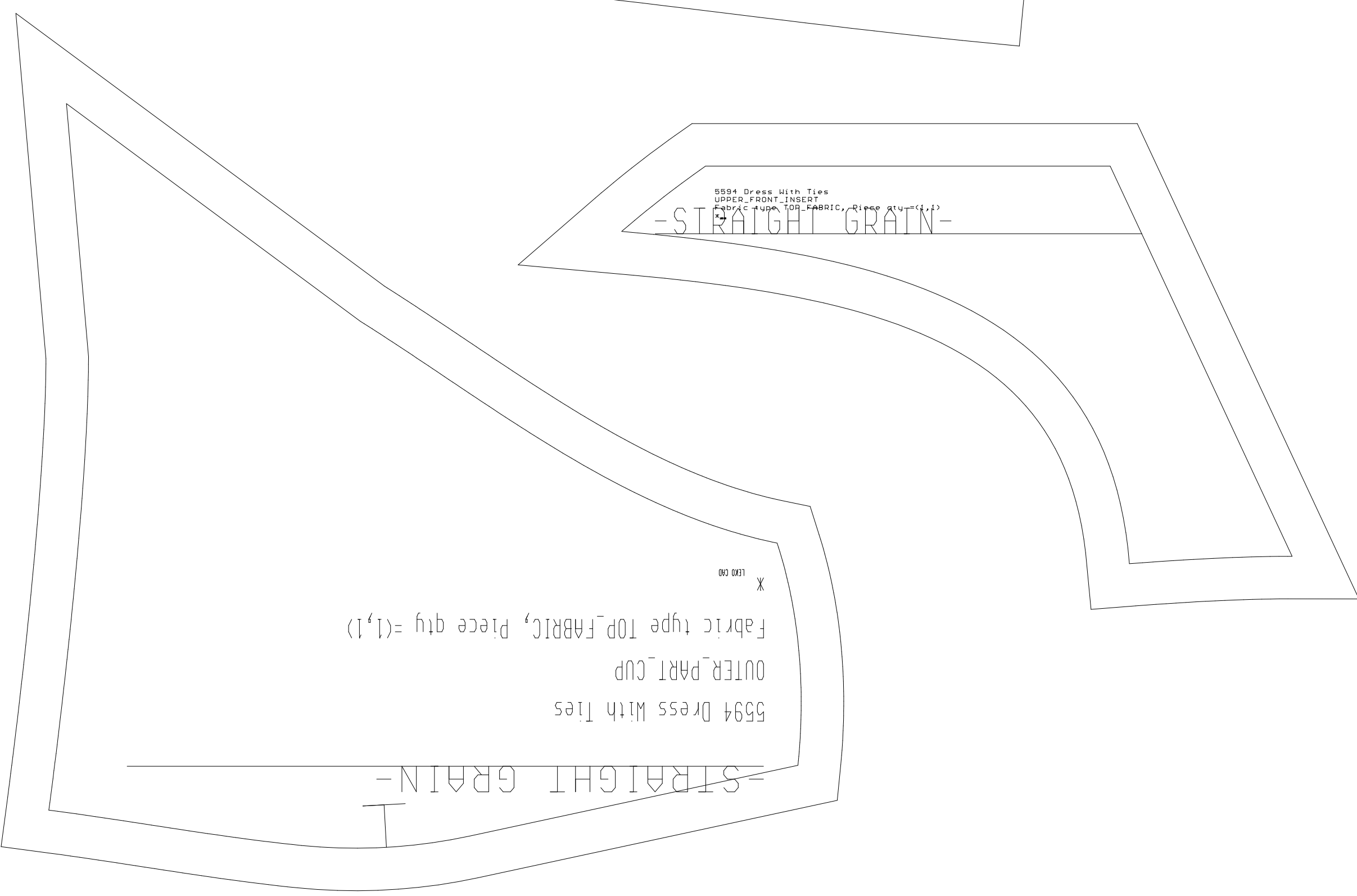
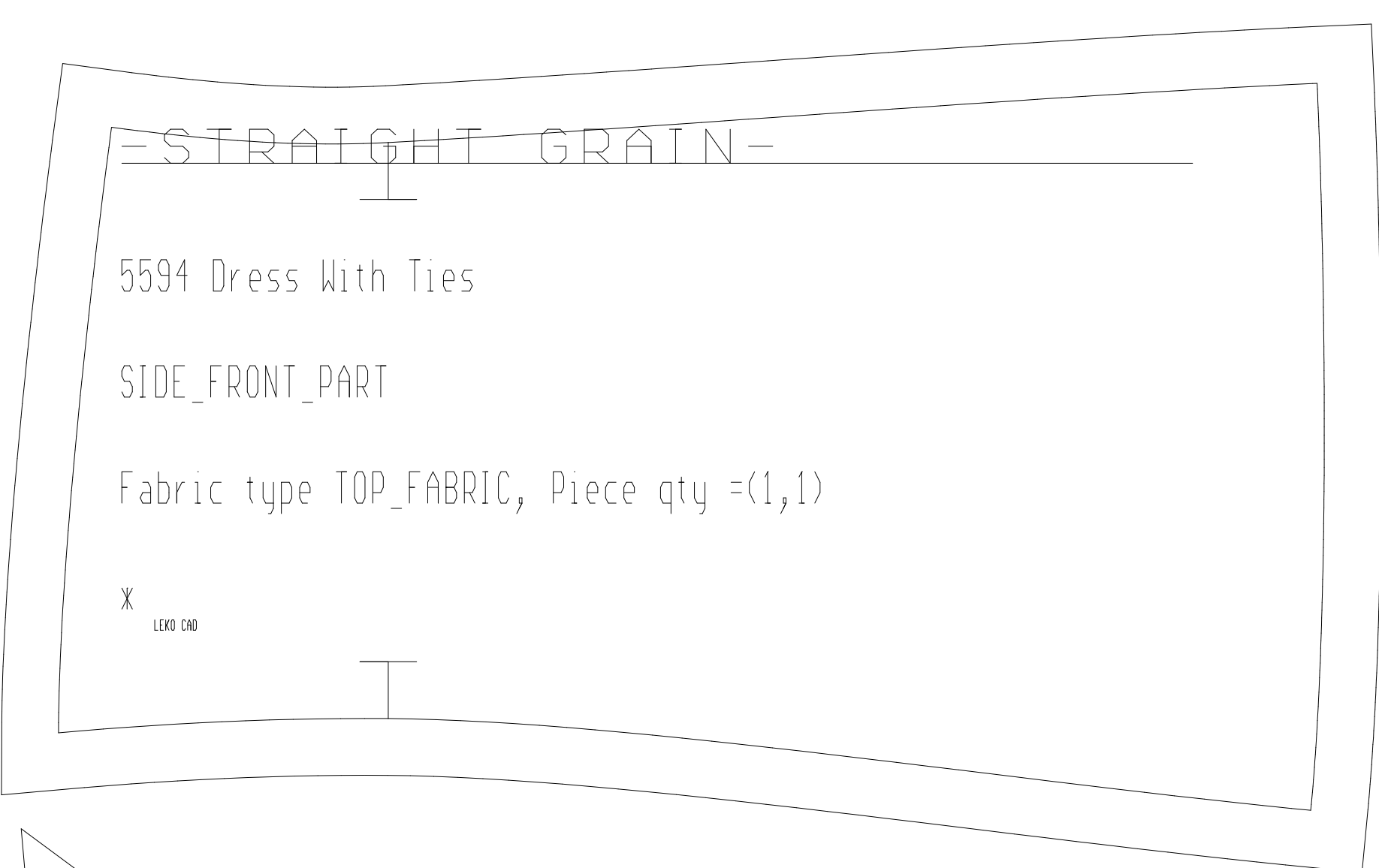
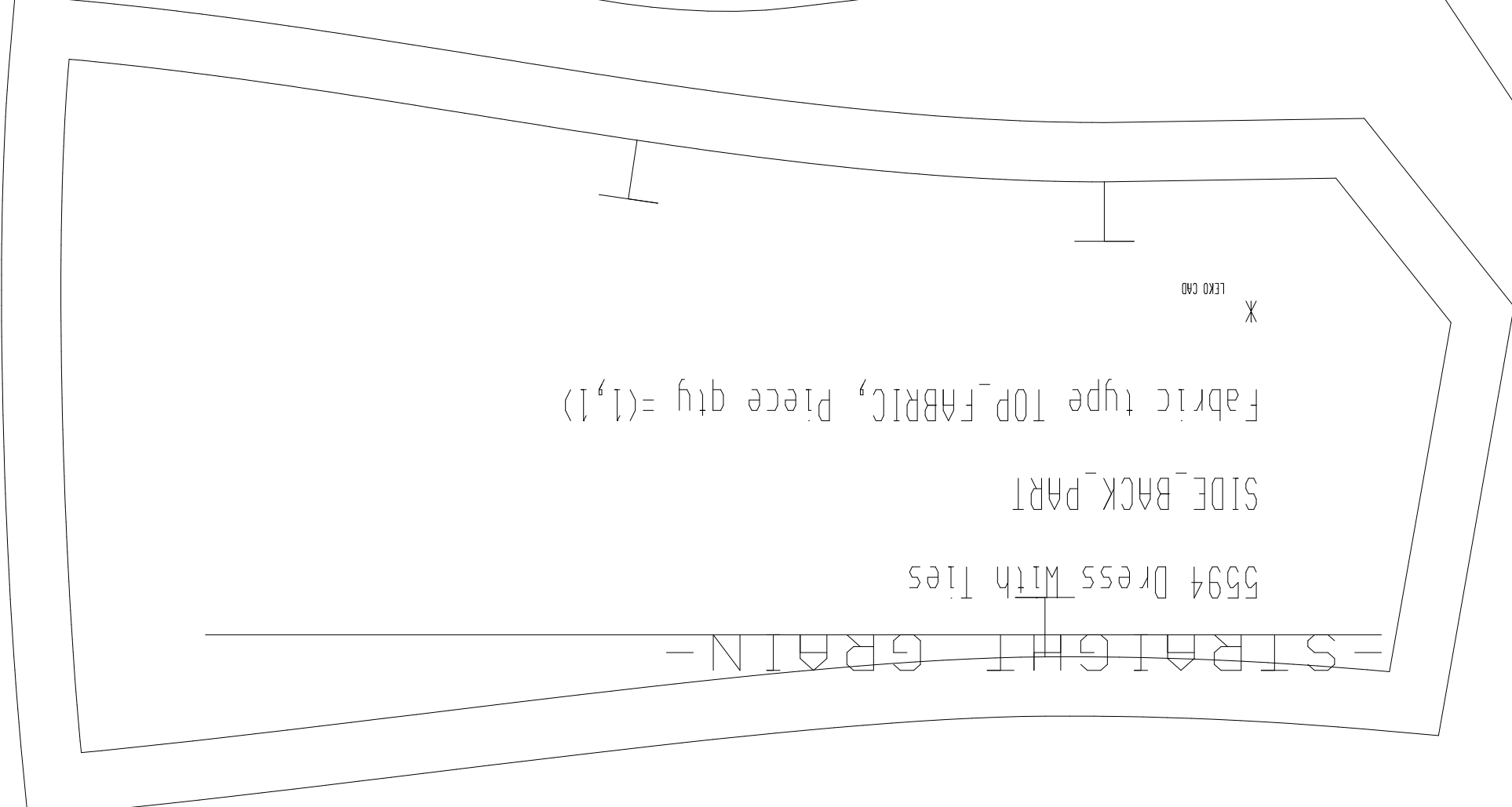
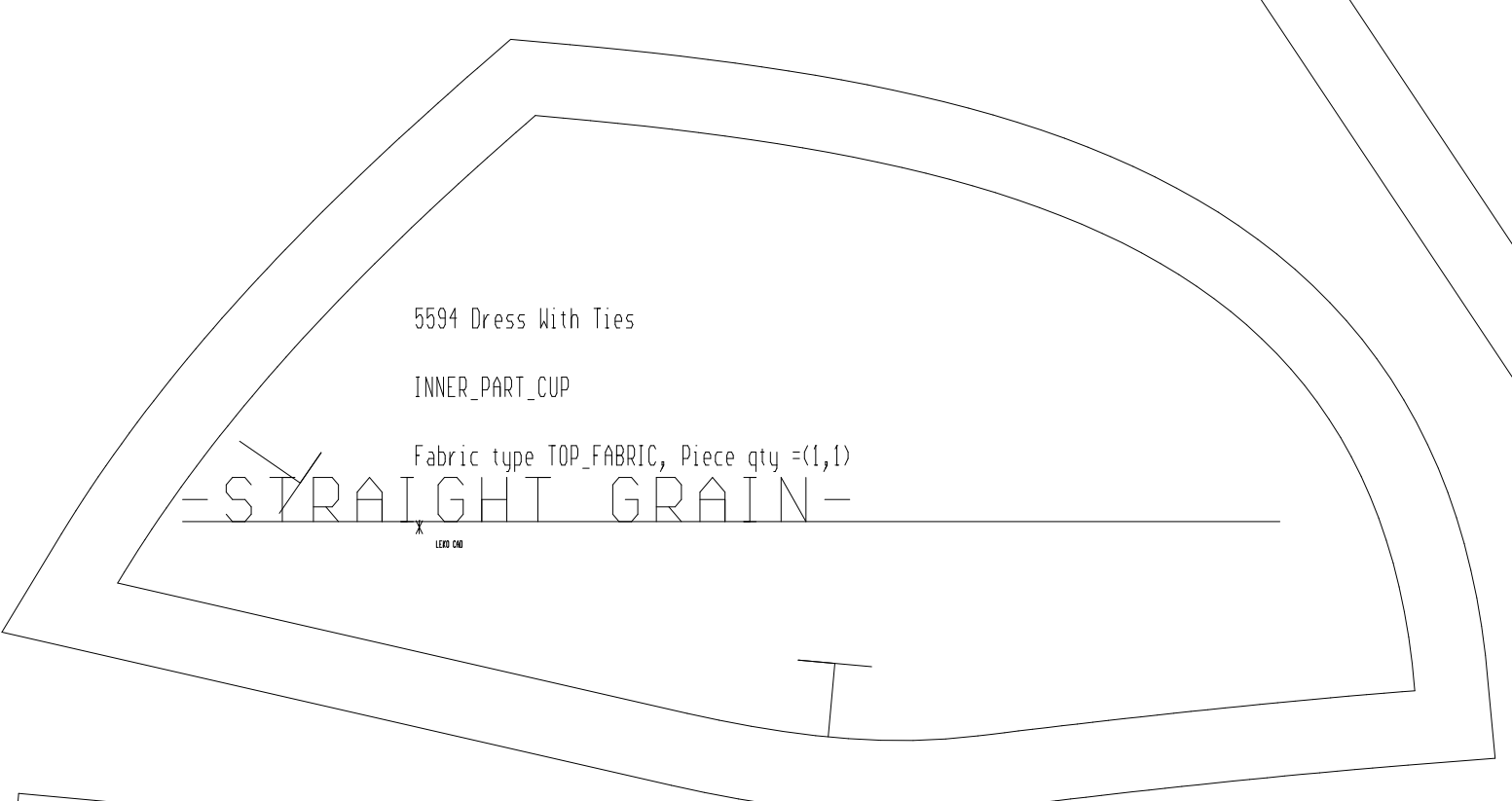
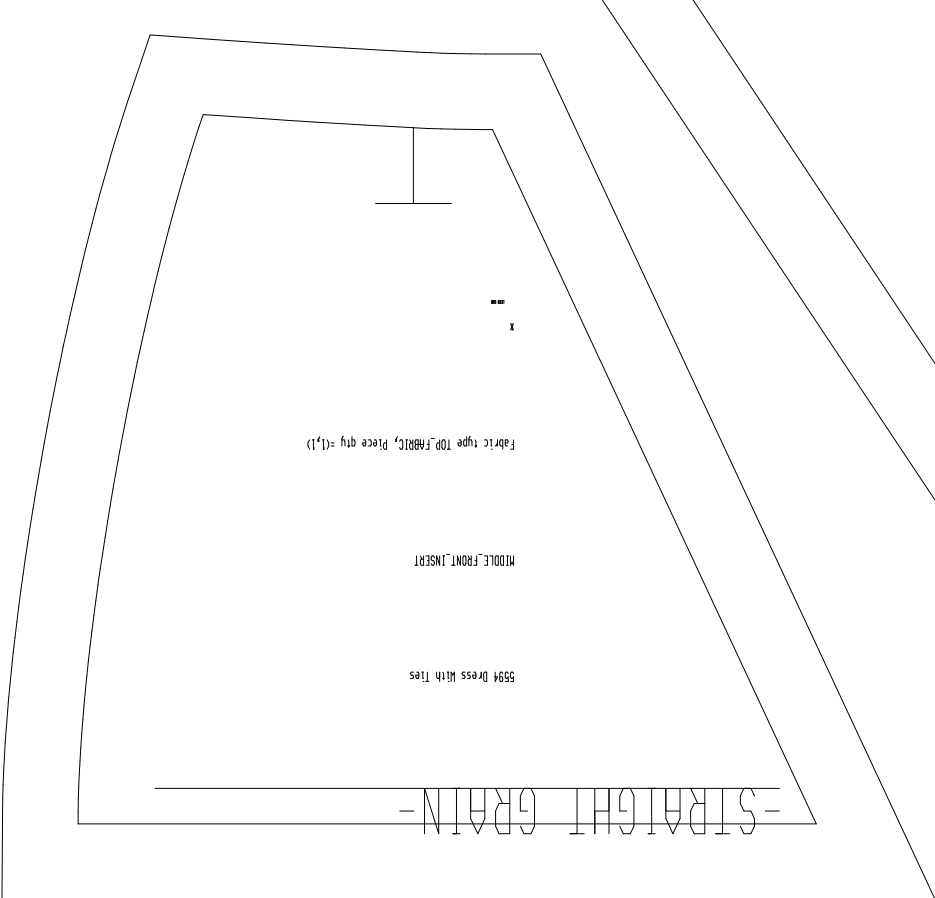

=STRAIGHT GRAIN=

=STRAIGHT GRAIN=

5594 Dress With Ties  
SKIRT\_BACK\_PART  
Fabric type TOP\_FABRIC, Piece qty =(1,0)  
X UNISEX

FOLD

=STRAIGHT GRAIN=

5594 Dress With Ties  
SHOULDER\_STRAP  
Fabric type TOP\_FABRIC, Piece qty =(2,2)  
X UNISEX